

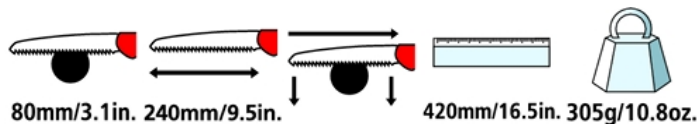

FELCO 621 - Verde

Sega a taglio tirante - Seg a taglio tirante - Lama 24 cm

Designed in Switzerland by FELCO, Made in South Korea, Guaranteed FELCO Quality, PATENT NO: US D500,656 S



- > **Affidabilità:** lama cromata in acciaio resistente alla corrosione / trattamento termico tramite impulsi delle punte dei denti / taglio netto e preciso / pezzi sostituibili
- > **Efficacia:** forma conica della lama per un taglio confortevole e senza inciampi / la forma e la disposizione dei denti evitano l'insudiciamento della lama / non necessita nessuna manutenzione
- > **Ergonomia:** manico comodo, antiderapante / astuccio per mancini o destri con passante di cintura staccabile



CONSIGLIATO PER

Il nostro consiglio (★ = Consigliato, ★ ★ = Fortemente consigliato, ★ ★ ★ = Scelta migliore)

Viticoltura	★ ★ ★
Frutticoltura	★ ★ ★
Parchi e giardini	★ ★ ★
Mano piccola	★ ★ ★
Mano media	★ ★ ★
Mano grande	★ ★ ★
Per destrorsi	★ ★ ★
Mancino	★ ★ ★



I MARCHI D'ECCELLENZA



Taglio tirante

La tecnica di taglio tirante riduce lo stress ed evita la torsione della lama.



Anti corrosione

Lama resistente alla corrosione in acciaio cromato.



Longevità del tranciante

La punta dei denti è indurita per impulso, che aumenta la longevità del bordo tranciante della sega.



Geometria dei denti

La geometria del dente è ottimizzata per il taglio di legname verde. Migliorata l'evacuazione dei trucioli e l'attacco più morbido evita gli scossoni al braccio.



Geometria della lama

La forma della lama lunga assicura il massimo comfort di lavoro riducendo le vibrazioni.



Ergonomia

Il manico anti-scivolo ed ergonomico offre una buona presa.



Con astuccio

Astuccio dotato di un passante staccabile per consentire l'uso della sega agganciata alla cintura. Adattabile agli utilizzatori destri e mancini.



ACCESSORI



FELCO 980

Prodotti per manutenzione
Spray

RICAMBI

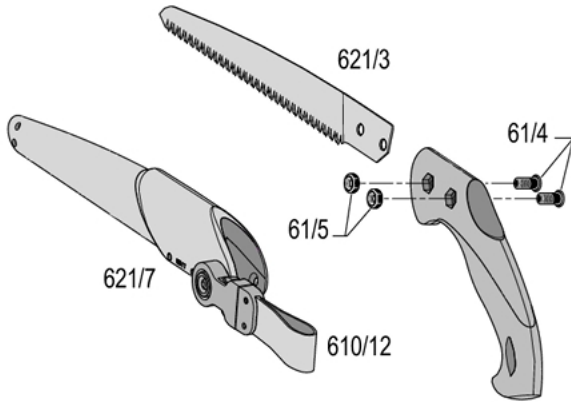

FELCO	RIF.	Descrizione	Composizione	Codice a barre UCC
	621/3	Lama	1x 621/3	 7 83929 40112 6
	61/4	Vite	1x 61/4	 7 83929 40227 7
	61/5	Dado	1x 61/5	 7 83929 40228 4
	610/12	Asola	1x 610/12	 7 83929 40229 1
	621/7	Fodero	1x 621/7	 7 83929 40233 8



SOSTITUZIONE DI PEZZI



Sostituzione della lama

Se l'attrezzo non taglia più bene, vi consigliamo di cambiarla.