

FELCO 31 - Verde

Forbice da patate - Buone prestazioni - Modello a battente

Made in Switzerland by FELCO



25mm/1in.



S



L



210mm/8.3in.



225g/7.9oz.



> **Affidabilità:** impugnature comode, leggere e solide in alluminio forgiato, garantite a vita* / lama in acciaio temperato di elevata qualità e battente regolabile in ottone avvitato / taglio netto e preciso / tutti pezzi sostituibili

> **Efficacia:** facile regolazione del taglio

> **Ergonomia:** protezione della mano grazie alla forma ideale delle impugnature / rivestimento antiscivolo

CONSIGLIATO PER

Il nostro consiglio (★ = Consigliato, ★ ★ = Fortemente consigliato, ★ ★ ★ = Scelta migliore)

Viticoltura	★ ★ ★
Frutticoltura	★ ★ ★
Orticoltura	★ ★ ★
Parchi e giardini	★ ★ ★
Vivaio	★ ★ ★
Mano piccola	★ ★ ★
Mano media	★ ★ ★
Mano grande	★ ★ ★
Per destrorsi	★ ★ ★
Mancino	★ ★ ★

I MARCHI D'ECCELLENZA

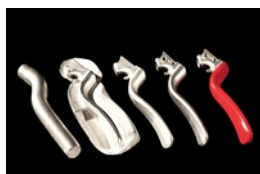

Impugnature in alluminio forgiato

Leggerezza, robustezza e rigidità grazie ad una lega di alluminio e al processo di sagomatura del materiale con stampaggio di precisione perfettamente controllato da FELCO. Parti garantite a vita*.

ACCESSORI



FELCO 902
Strumenti per l'affilatura
Pietra per affilare



FELCO 903
Strumenti per l'affilatura
Affilatoio



FELCO 910
Astucci
In cuoio - Con passante e clip a
molla



FELCO 912
Astucci
In cuoio - Con clip a molla



FELCO 980
Prodotti per manutenzione
Spray







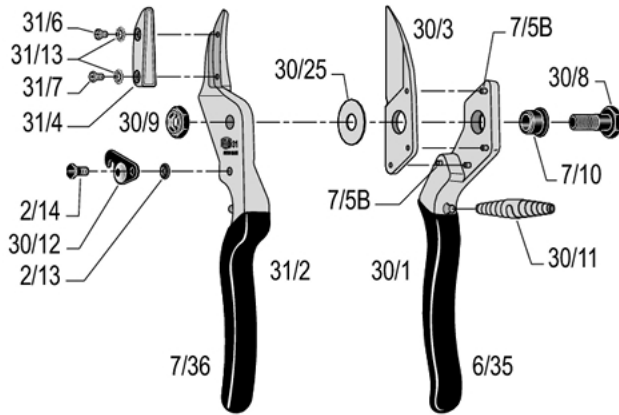



















FELCO 990
Prodotti per manutenzione
Grasso

RICAMBI



FELCO	RIF.	Descrizione	Composizione	Codice a barre UCC
	30/3	Lama con rosetta	1x 30/3 + 1x 30/25	
	31/4	Battente con viti	1x 31/4 + 1x 31/6 + 1x 31/7 + 2x 31/13	
	30/90	Kit	1x 30/8 + 1x 30/9 + 1x 30/25	
	30/91	Kit	2x 30/11	
	30/92	Kit	1x 2/13 + 1x 30/12 + 1x 2/14	
	30/1	Manico senza lama	1x 30/1 + 4x 7/5B + 1x 7/10 + 1x 6/35	
	31/2	Manico senza battente	1x 31/2 + 1x 2/13 + 1x 30/12 + 1x 2/14 + 1x 7/36	
	6/35	Rivestimento per portalama	1x 6/35	
	7/36	Rivestimento per manico controlama / battente	1x 7/36	

	7/5B	Ribattino per lama	1x 7/5B	 7 83929 40240 6
	31/6	Vite per battente 6 mm	1x 31/6	 7 83929 40352 6
	31/7	Vite per battente 8 mm	1x 31/7	 7 83929 40354 0
	30/8	Bullone	1x 30/8	 7 83929 40198 0
	30/9	Dado	1x 30/9	 7 83929 40199 7
	7/10	Boccola	1x 7/10	 7 83929 40235 2
	30/25	Rondella	1x 30/25	 7 83929 40195 9
	31/13	Rondella	1x 31/13	 7 83929 40356 4
	30/11	Molla nichelata	1x 30/11	 7 83929 40192 8
	30/12	Chiusura	1x 30/12	 7 83929 40193 5
	2/13	Ranella per chiusura	1x 2/13	 7 83929 40154 6
	2/14	Vite per chiusura	1x 2/14	 7 83929 40155 3

MANUTENZIONE



Pulizia

Vi consigliamo di pulire il vostro attrezzo dopo ogni utilizzo.
Se il vostro attrezzo è particolarmente sporco o suscettibile alla ruggine dopo essere stato esposto all'umidità, non posticipatene la pulizia.



Lubrificazione

Dopo la pulizia, vi consigliamo di oliare l'attrezzo per proteggerlo dalla corrosione. L'olio permette inoltre di sbloccarlo in caso d'inceppamento.



Affilamento

Vi consigliamo di affilare il vostro attrezzo almeno una volta al giorno, ma se pensate che non tagli più come prima, affilatelo subito!



Smontaggio

Vi consigliamo di smontare regolarmente il vostro attrezzo, e al più tardi quando vi sembra che si sia inceppato.

SOSTITUZIONE DI PEZZI



Sostituzione della lama

Se la lama e la controlama non s'incrociano più, o se la lama è troppo danneggiata, vi consigliamo di cambiarla.

Calibrate il gioco della lama e della controlama regolando la forza di serraggio del dado. La lama deve sfregare contro la controlama per i 2/3 della sua lunghezza.



Sostituzione della chiusura

Se la chiusura è danneggiata e si allenta durante l'uso nonostante ne abbiate regolato la vite, sostituirla.



Sostituzione del rivestimento dei manici

Se il rivestimento è troppo danneggiato, potete sostituirlo.

Lasciate il rivestimento a mollo per 2 minuti in acqua bollente – colla consigliata: Loctite 415.